

09/06/15 (rev-3)

***NRG Pro &
NRG XC***



Manual

 **APCO Aviation**
Setting Future Standards



CONTENTS:

1	NRG PRO TECHNICAL DATA	4
2	DISCLAIMER OF LIABILITY	5
3	CONSTRUCTION	5
4	MATERIALS	5
5	FLEXON® Batten system:	6
6	TRIMMING	6
7	HARNESS	7
8	SPEED SYSTEM	7
8.1	ASSEMBLY & ADJUSTMENT	7
8.2	OPTION 1	7
8.3	OPTION 2	8
9	EMERGENCY PARACHUTE ATTACHMENT	9
10	RISERS	9
11	TRIMMERS	11
12	OAA (One Action Acceleration)	12
13	HIT VALVES (High speed In-Take)	13
14	SRS – Stall Recovery System	14
15	INSPECTION	16
15.1	GENERAL	16
15.2	BRAKE SETTING	16
15.3	Brake Operation	17
15.4	FIRST CHECK AND PREFLIGHT INSPECTION	18
15.5	REGULAR INSPECTION CHECKS	18
15.6	LINE MAINTENANCE	18
16	PARAGLIDING	19
16.1	TAKE OFF	19
16.1.1	LAYOUT	19
16.1.2	ALPINE LAUNCH OR FORWARD LAUNCH	19
16.1.3	STRONG WIND AND REVERSE LAUNCH	20
16.1.4	TOW OR WINCH LAUNCHING	20
16.2	FLIGHT TECHNIQUES	20
16.2.1	FLYING SPEED	20
16.2.2	THERMAL FLYING	21
16.2.3	ASYMMETRIC COLLAPSE	21
16.2.4	CRAVAT	21
16.2.5	FRONT STALL OR SYMMETRIC COLLAPSE	21
16.2.6	B-STALL	22
16.2.7	BIG EARS	22
16.2.8	DEEP STALL OR PARACHUTAL STALL	22
16.2.9	SPIRAL DIVES	22
16.2.10	STRONG TURBULENCE	23
16.2.11	STEERING NOT FUNCTIONING	23
16.2.12	LANDING	23
16.2.13	TREE LANDING	24
16.2.14	WATER LANDING	24
17	POWERED FLYING	25
17.1	FIRST FLIGHTS	25
17.2	TAKE-OFF	25
17.2.1	FORWARD LAUNCH	25
17.2.2	REVERSE LAUNCH (In strong wind)	27





17.2.3	CLIMBING	28
17.3	LEVEL FLIGHT	29
17.4	TRIMMERS AND SPEED-SYSTEM SETTINGS	29
17.5	LANDING	30
17.5.1	POWER OFF LANDING	30
17.5.2	POWERED LANDING	30
18	PACKING	31
19	MAINTENANCE & CLEANING	31
19.1	BUTT HOLES (Velcro closure on trailing edge tip)	31
20	STORAGE	32
21	DAMAGE	32
22	GENERAL ADVICE	32
23	NRG PRO 16.5 SKETCHES	33
24	NRG PRO 17.5 SKETCHES	34
25	NRG PRO 18.5 SKETCHES	35
26	NRG XC 16.5 SKETCHES	36
27	NRG XC 17.5 SKETCHES	37
28	NRG XC 18.5 SKETCHES	38

WARNING

This is not a training manual. It is extremely dangerous to yourself and others to attempt to fly this or any paraglider without first completing a flying course given by a qualified instructor.

Apco Aviation's gliders are carefully manufactured and inspected by the factory. Please use the glider only as described in this manual. Do not make any changes to the glider.

AS WITH ANY SPORT - WITHOUT TAKING THE APPROPRIATE PRECAUTIONS, PARAGLIDING CAN BE DANGEROUS.





1 NRG PRO TECHNICAL DATA

Size	16.5	17.5	18.5
Cells	50	52	54
Area m ²	16.52	17.5	18.48
Area (projected) m ²	13.81	14.63	15.45
Span (incl. Stabiliser) m	9.57	10.05	10.53
Span (projected) m	7.49	7.86	8.24
Aspect Ratio	5.55	5.77	5.99
Aspect Ratio (projected)	4.06	4.22	4.38
Pilot Weight (all up + paramotor) Kg	70-105	90-125	105-140
Weight of Canopy Kg	4.18	4.45	4.72
Root Cord m	2.07	2.07	2.07
Tip Cord m	0.4	0.4	0.4
Length of Lines on B m	5.78	6.03	6.28
Total length of line used m	305	325	348
LINES			
	Material	Diameter	Strength
Top	Dyneema	1.0mm	90kg
Mid; (a1,b1,c1,d1)	Vektran	1.0mm	153kg
Mid;,a,b,c,d,**Brake	Vektran	0.9mm	115kg
Bottom A3;A5;B3;B5	Super Aramid	1.4mm	254kg
Bottom A1;B1	Super Aramid	1.6mm	325kg
Bottom C,D,St	Super Aramid	1.0mm	137kg
Brake Cascades; st top	Vektran	0.6mm	50kg
Steering Lines	Polyester	2.0mm	85kg
FABRIC			
Sail Cloth	"Zero Porosity" Ripstop Nylon		
Certification	Load test Pending		

GLIDER PERFORMANCE DATA	
V-min.	27km/h
V-trim (-) / V-trim (0)	39/49 km/h
V-trim off	58 km/h
V-max.	80 km/h
Min Sink (at optimum wing loading)	1.4 m/s





2 DISCLAIMER OF LIABILITY

Taking into consideration the inherent risk in paragliding or hang gliding, (free flying and motorized), it must be expressly understood that the manufacturer and seller do not assume any responsibility for accidents, losses and direct or indirect damage following the use or misuse of this product.

APCO Aviation Ltd. is engaged in the manufacture and sale of hang gliding, paragliding, motorized Para/hang gliding and emergency parachute equipment.

This equipment should be used under proper conditions and after proper instruction from a qualified instructor. APCO Aviation Ltd. has no control over the use of this equipment and a person using this equipment assumes all risks of damage or injury.

APCO Aviation Ltd. disclaims any liability or responsibility for injuries or damages resulting from the use of this equipment.

The glider is designed to perform in the frame of the required class as certified.

3 CONSTRUCTION

The glider is constructed with a top and bottom surface, connected by ribs.

One top and bottom panel, together with the connecting ribs is called a cell.

Each cell has an opening on the front lower part. The cells fill with air forcing the panels to take the shape dictated by the airfoil (rib) section.

On either side the wing ends in a stabilizer or wing tip, which provides straight-line (Yaw) stability and produces some outward lift to keep the span-wise tension.

The front part of the ribs use APCO's FLEXON batten system to keep the leading edge shaped at high speeds and in turbulent air. They also improve the performance and the launch characteristics of the glider.

The line hook-up points are made of Dyneema and imbedded in the bottom surface of the wing for minimal drag and maximum performance.

4 MATERIALS

The glider is made from tear resistant Ripstop Nylon cloth, which is P.U. coated to zero porosity and then siliconized to give the fabric high resistance to the elements. Different cloth is used for the top, bottom and ribs due to their different functions.

The lines are made of superaramid covered with a polyester sheath for protection against UV, wear and abrasion.





The bottom section of the brake lines are made of polyester because of its better mechanical properties.

The maillon quick links that attach the lines to the risers are made of stainless steel.

5 FLEXON® Batten system:

New generation FLEXON® batten system incorporated (see below) in the leading edge of the ribs, insuring perfect profile shape (instead of traditional Mylar reinforcement). FLEXON® battens reduce the weight of the glider by an additional 500gr. and unlike Mylar reinforcement will guarantee no deterioration in performance or launch.

Additional advantage of FLEXON batten is that it is practically indestructible, safeguarding the performance and launch over the lifespan of the glider.

How it Works:

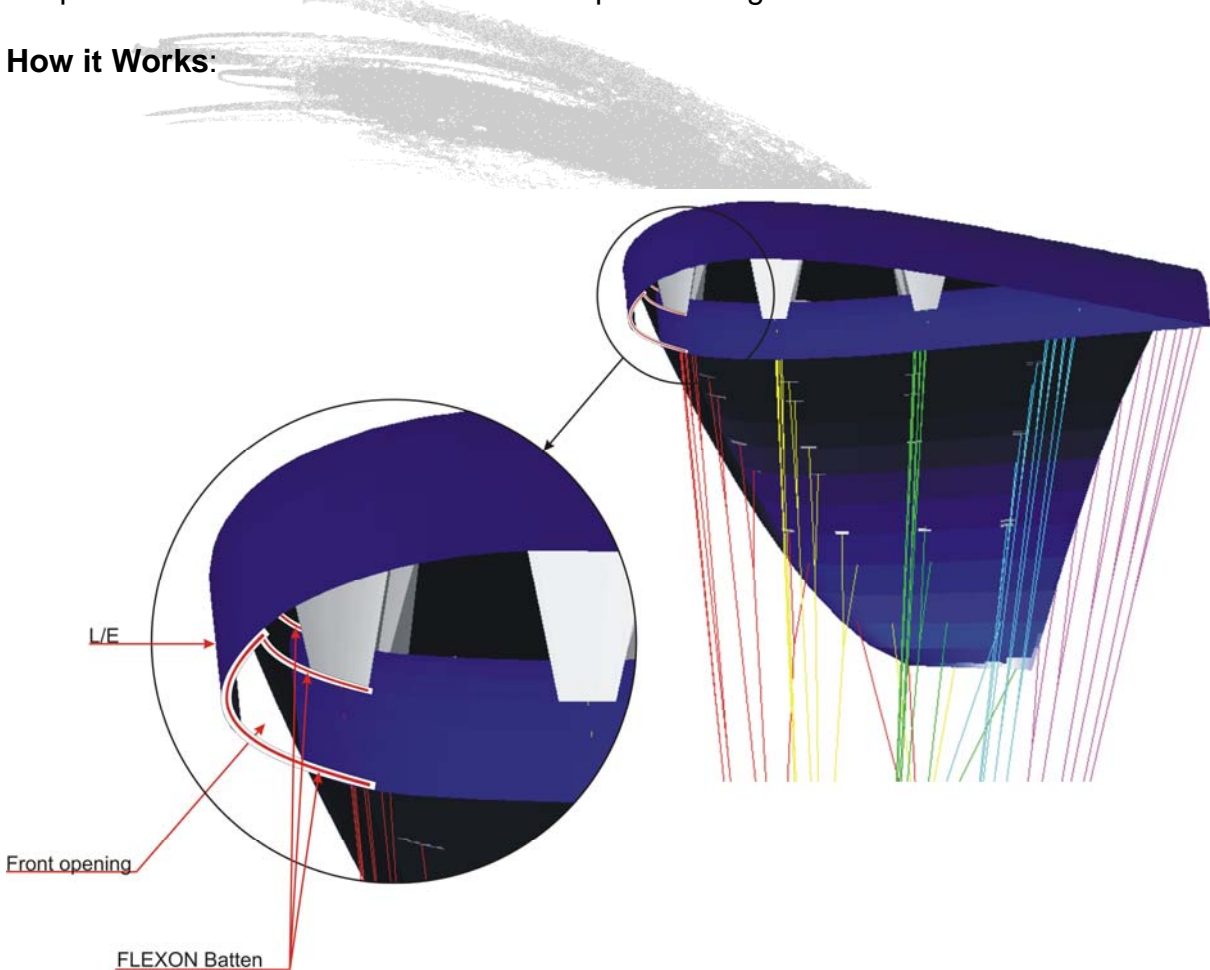

6 TRIMMING

All Apco gliders are trimmed for optimum performance combined with unsurpassed safety. It is very important not to re-trim or tamper with any of the lines or risers as this may alter the performance and safety. Trimming of the brake line should be done in accordance with this manual and carefully checked before flying.





7 HARNESS

All of Apco's gliders are developed with the use of ABS (Automatic Bracing System) type harnesses without cross bracing. We recommend the use of an ABS harness with all our gliders. All certified harnesses can be used with our gliders. For best safety and performance we recommend an Apco harness equipped with a Mayday emergency parachute.

CAUTION:

WE RECOMMEND NOT TO USE CROSS BRACING STRAPS.

APCO GLIDERS ARE DEVELOPED AND TESTED WITHOUT THE USE OF CROSS BRACING. USING AN ABS HARNESS WITH CHEST STRAP SET AT THE SPECIFIED WIDTH (CHECK THE CERTIFICATION STICKER ON YOUR GLIDER) WILL RESULT IN THE HIGHEST PASSIVE SAFETY ON YOUR GLIDER.

8 SPEED SYSTEM

8.1 ASSEMBLY & ADJUSTMENT

Apco gliders are supplied with a speed system as illustrated in option I. The pilot can change the speed system to the traditional "Apco" speed system to use the full accelerator range depending on the pulley arrangement on the harness being used (Option II)

8.2 OPTION 1

First attach the harness to the glider. Remove the Chain Link from the end of the accelerator line attached to the speed bar, then thread it through the elasticized ring on the harness, then through harness pulley and then re-attach it to the Chain link with a larks-head knot. Hook the Chain link onto the Chain Link on the riser of the corresponding side. Sit in the harness and have someone hold the riser up in a flying position for you. Adjust the speed bar line by pulling the end through the speed bar tube and moving the knot. The Bar should be about 10 cm (or closer if you have a second step) away from the front of the harness seat. This allows you to easily reach the bar with your foot, and will allow you to use the full range of the speed bar if you extend your legs fully. Do not adjust the speed system too short, as this will cause it to be activated permanently while flying, and could be dangerous. It is possible to fit a second step to the system, if one has trouble using the full range of the system (supplied separately).



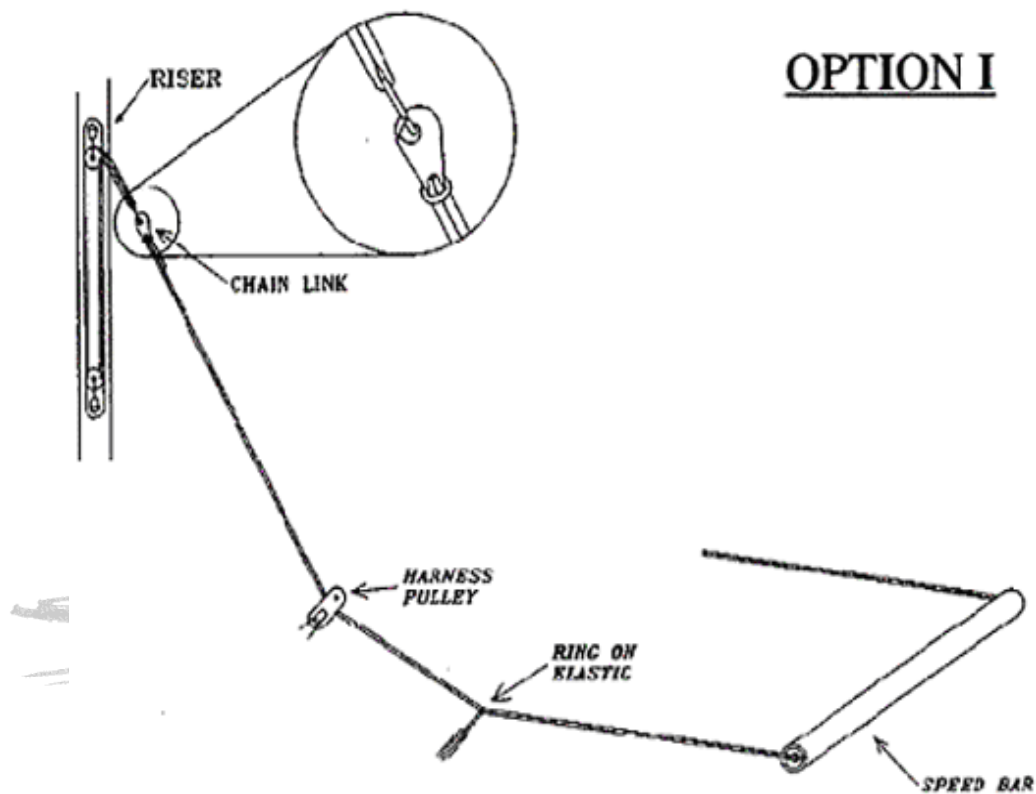

Figure 8-1

8.3 OPTION 2

First attach the harness to the glider, then thread the accelerator line from the top pulley on the riser, through the pulleys (and the elasticized ring if present) on your harness and then attach it to the supplied speed bar. To adjust the length and activation point of the speed system, sit in the harness and ask someone to hold the riser up in a flying position. By pulling out the end of the line protruding above the upper pulley on the riser and by moving the knot you can adjust the speed system. The Bar should be about 10 cm (or closer if you have a second step) away from the front of the harness seat. This allows you to use the full range of the speed bar if you extend your legs fully. Do not adjust the speed system too short as this will cause the speed system to be activated permanently while flying and could be dangerous. It is possible to fit a second step to the system if the pilot has trouble using the full range of the speed system (second step is supplied separately).



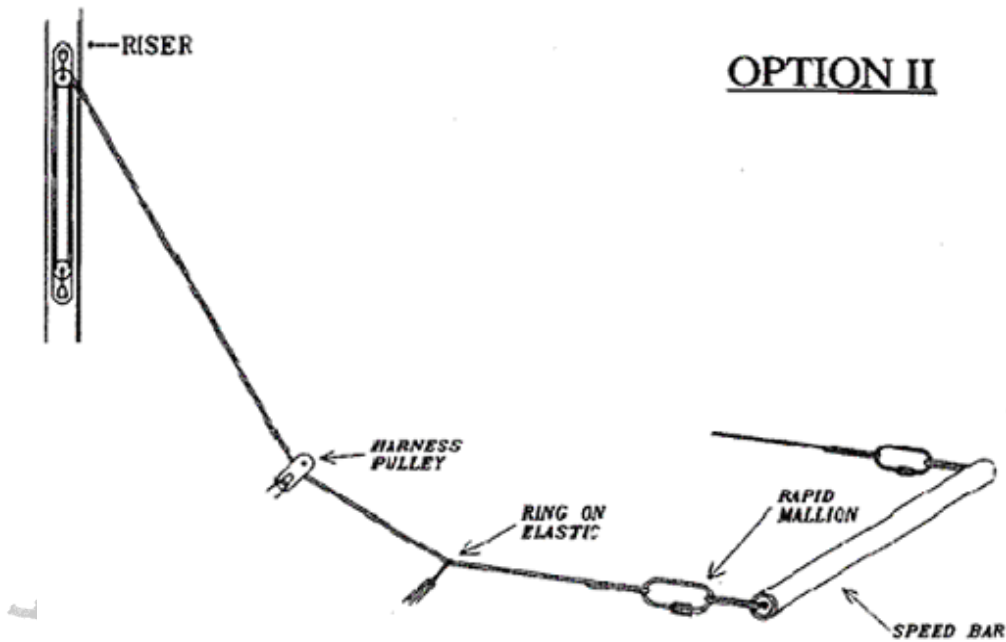

Figure 8-2

WARNING:

The use of the speed system in turbulent conditions or close to the ground is dangerous. While flying with the accelerator, the glider has a reduced angle of attack and is therefore more susceptible to turbulence and may collapse or partially deflate. Gliders react faster when accelerated and may turn more. The accelerator should immediately be released in this case.

9 EMERGENCY PARACHUTE ATTACHMENT

It is recommended to use a certified rescue parachute when flying. Attaching the rescue parachute should be done in accordance with the recommendation of the harness and reserve parachute manufacturer.

10 RISERS

The NRG PRO is supplied with risers featuring a split A riser. The 1st A-riser attaches to the central two A lines (A1 & A3). The second A-riser is attached to the outermost A line (A5). At no time should the pilot change the risers or use risers not intended for this specific glider as this will affect the performance and safety of the glider.

The riser is equipped with both an accelerator and trimmers with two hook-in points to accommodate torque compensation for left and right prop rotation

The brake line is guided through upper pulley for low hook in point harnesses and adjusted as per Section 16.2(see Figure 16-1).

For high hook in harnesses use the same brake line setting guiding the brake line through the lower brake guide pulley position.



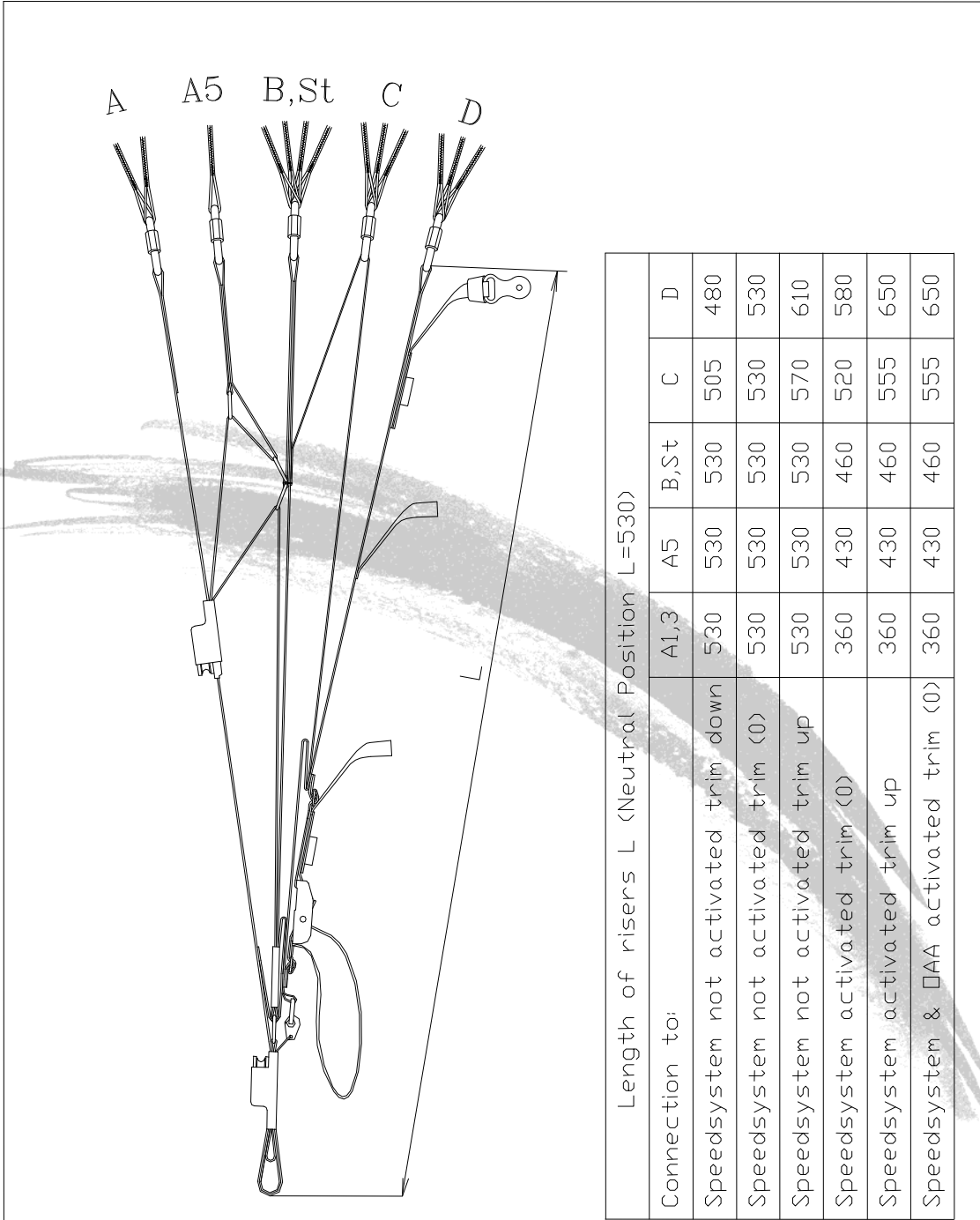

* All measurements are in mm

Drawn by Adam Wechsler	Part N 70090R/L	Toll	Quantity per glider 2
Date 28.07.14	Name RISER		Drawing N
Scale			
Approved Anatoly Cohn			
APCO Aviation LTD.		Product NRG Pro	



11 TRIMMERS

The NRG PRO risers are equipped with replaceable trimmers for accelerated flight. The neutral setting is when the A/B/C riser lengths are equal.

Trimmers should be used when higher speed is required and you wish to accelerate the glider.

Replaceable trimmer system

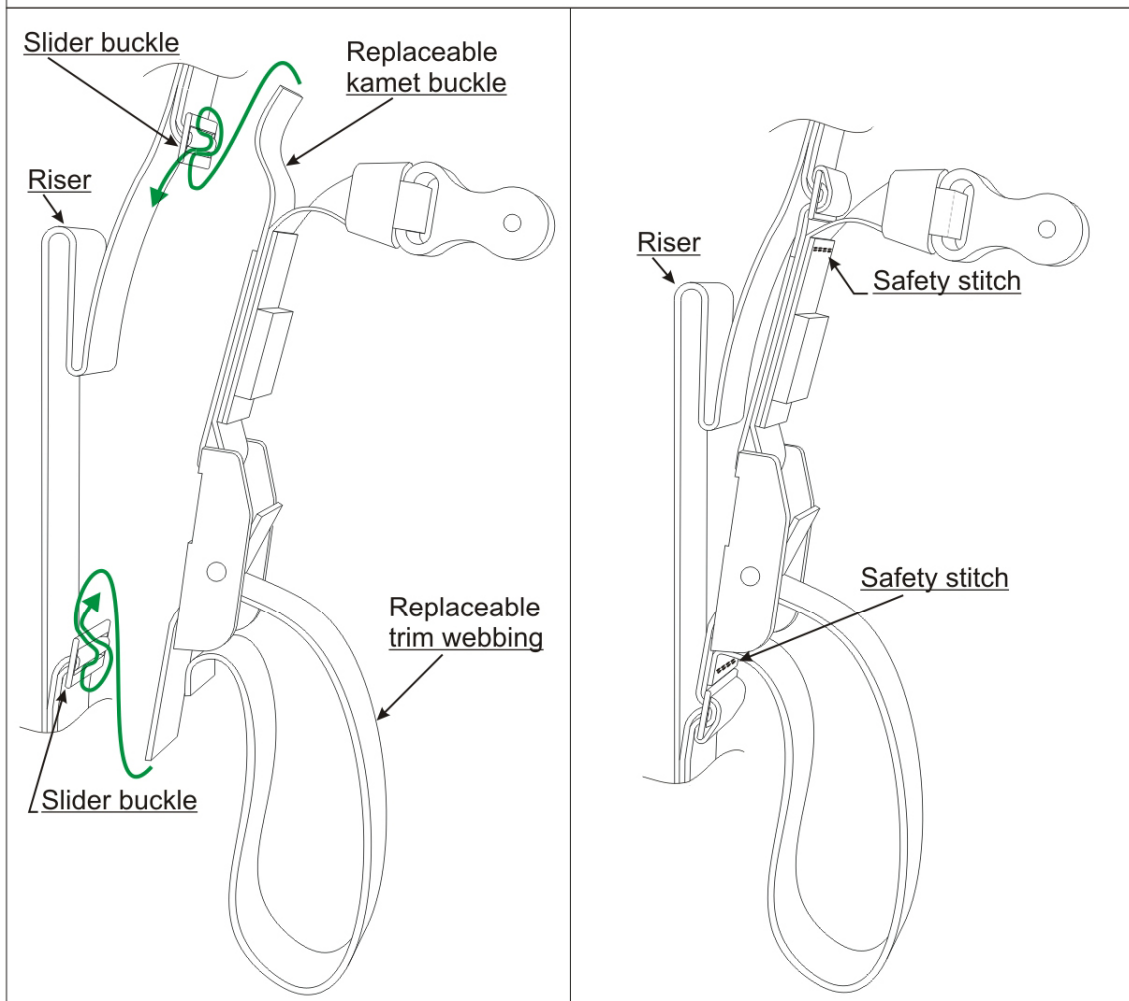

The diagram illustrates the process of replacing trimmer webbing or kamet. The left side shows the trimmer in its neutral state, with labels for 'Slider buckle', 'Riser', 'Replaceable kamet buckle', and 'Replaceable trim webbing'. Green arrows indicate the path of the webbing through the slider buckles. The right side shows the trimmer after the webbing has been removed, with labels for 'Riser' and 'Safety stitch'.

1. Undo the safety stitch of kamet or trim webbing, depending on what requires replacement.
2. Take out the kamet or trim webbing requiring replacement, by removing it from the slider buckle.
3. Replace trim webbing or kamet with new by guiding it back through the slider buckle, verify the trim range is unchanged, on trim speed all the riser branches are at equal height. When kamet fully released it should not retain any load (all the load is on the fully released D branch of the riser).
4. Restitch the safety stitch to lock the configuration of the trim in place.





12 OAA (One Action Acceleration)

OAA is an innovative system that stands for "One action acceleration system - OAA".

The OAA allows pilots to simultaneously operate both the speed system and the trimmer for optimized angle of attack at any given speed. With OAA, when using the speed system, the trimmers are released gradually according to the position of the speed bar. This allows for a larger speed range that can be fully used in one swift action of the speed bar.

In order to engage the OAA one must detach the brommel hooks connected to the rear risers below the trimmers. **Prior to using the speed system one must move the trimmers to the neutral position (all risers level).**

To disengage the OAA one must reattach the brommel hooks on the rear riser.

When operating the speed system with the OAA disengaged one must release the trimmers open before activating the speed system.

One Action Acceleration OAA

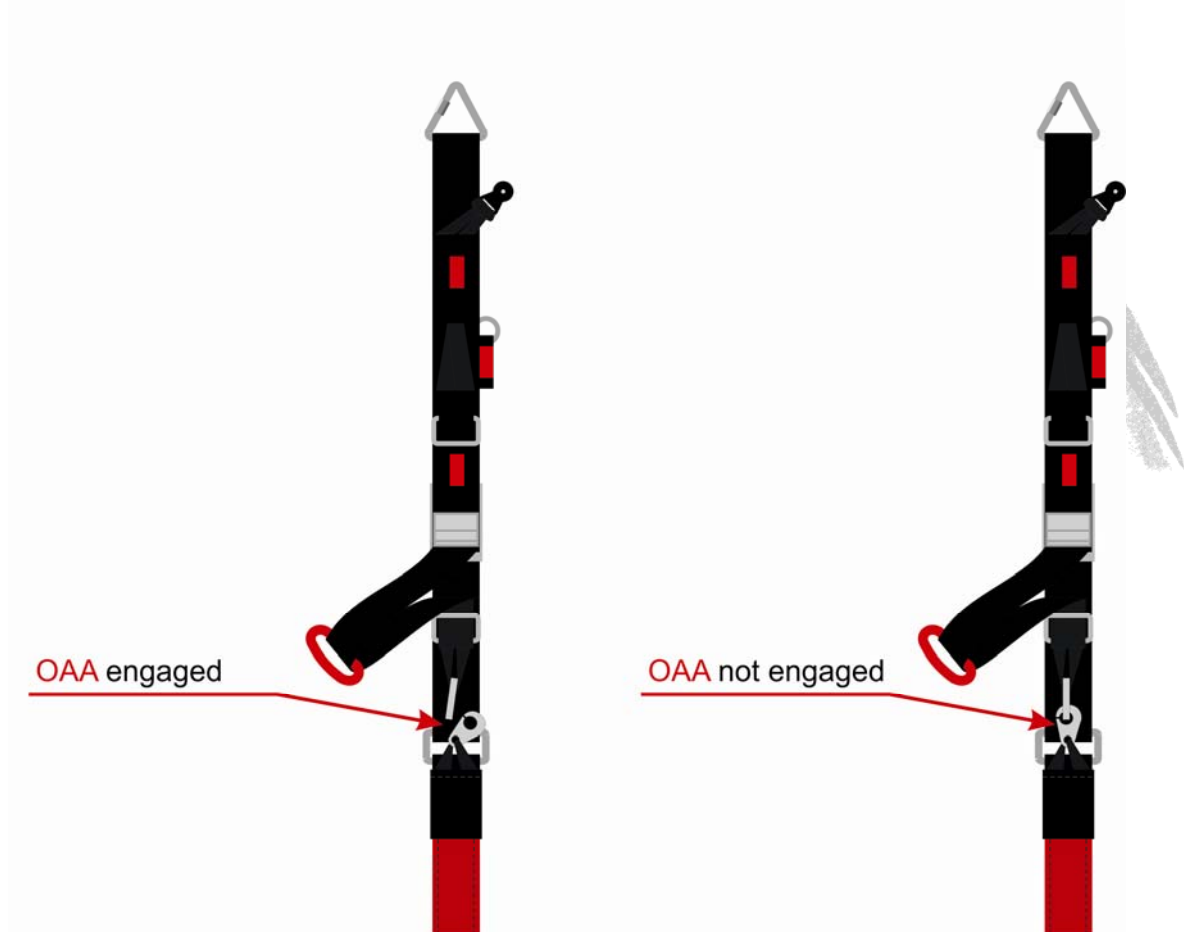

13 HIT VALVES (High speed In-Take)

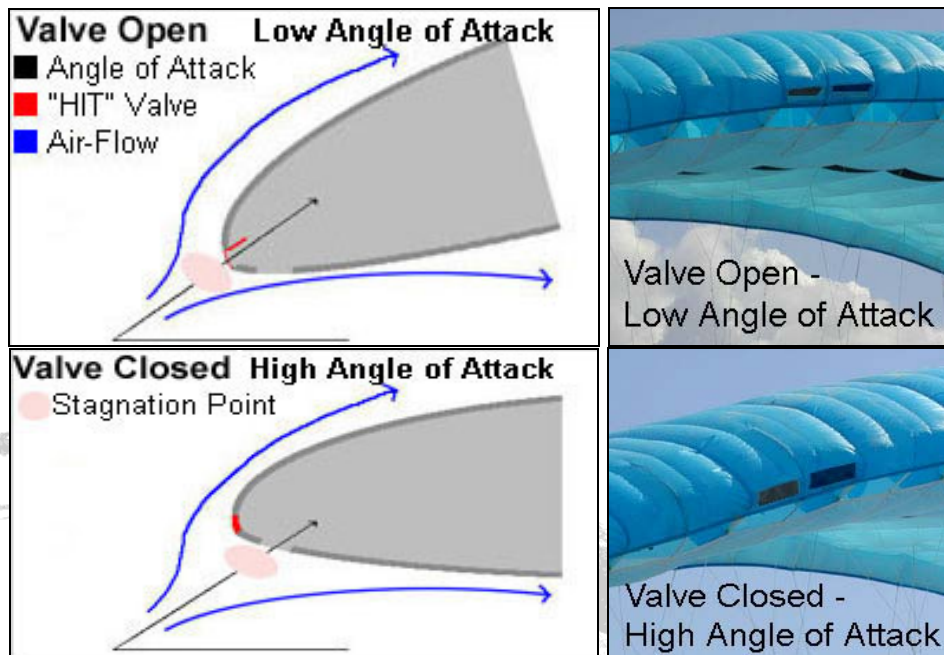

The NRG PRO is equipped with an Active HIT Valve system (patent pending) to improve the overall performance and safety of the wing especially during accelerated flight.

The valve system allows maximum inflow of air when the glider acquires a lower angle of attack while accelerated. HIT valves open and close in flight to increase the internal pressure of the glider.

For the valves to work properly it is important to keep them wrinkle free especially in sub zero temperatures. Make sure the valves are lying flat and are in the closed position when you fold the glider. Before launch the pilot should check all the valves and verify that they are flat and cover the entire area of the mesh opening. Creased and wrinkled valves will not adversely affect the safety of the wing.





14 SRS – Stall Recovery System

The **NRG PRO** features a new, innovative, riser design allowing the pilot to slow down the glider to minimum speed without risking getting caught in deep stall (parachutal). The **SRS** (patent pending) takes advantage of simple yet proven aeronautical and physical principles.

When flying, most of the load is applied to the front third of the wing. This means that the A lines bear significantly more load than the C+D lines together. However, when the glider is in deep stall (parachutal), the load is distributed almost evenly along the wing chord. Thus, in parachutal, the load on the C+D lines is considerably higher than on the A lines. Using this principle, we designed a self-compensating angle of attack (AofA) system based on a sliding riser concept.

The C+D riser join the A risers and slide in opposite direction. In flight, the A riser is taut and pulls the C+D to trim position. When forced into parachutal, The C+D riser elevate and pull down the A riser, accelerating the glider out of parachutal. Once recovered, the risers automatically resume trim position.



APCO SRS - Automatic Stall Recovery System

1

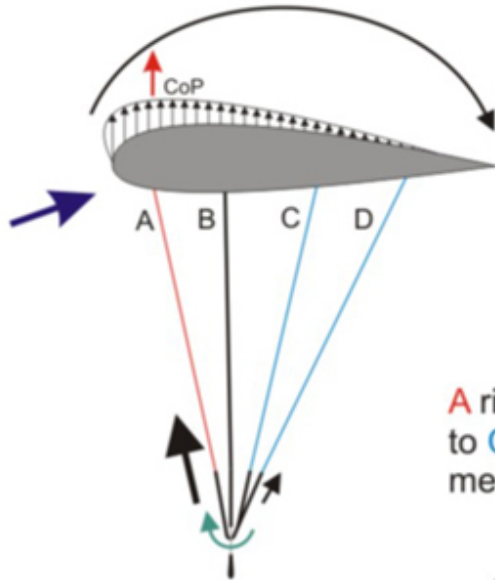

Load distribution in flight

2

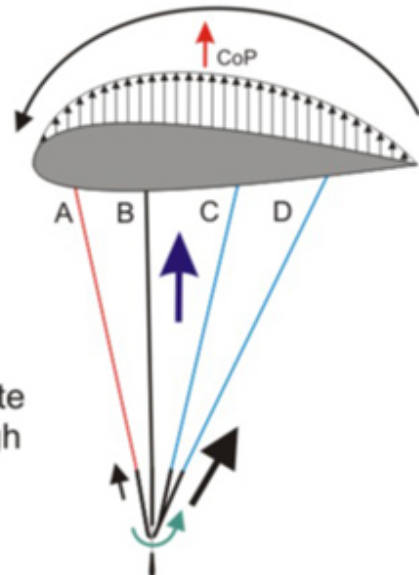

Load distribution in deep stall

A riser slides opposite to C&D risers through metal loop.

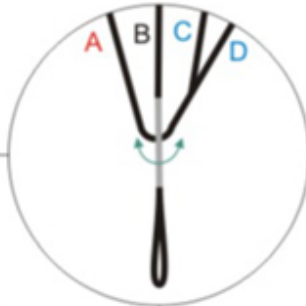

3

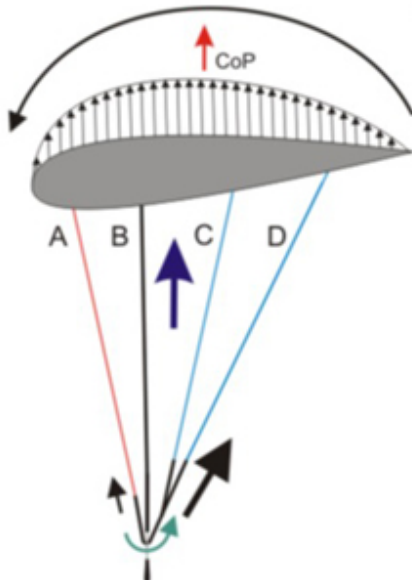

Automatic compensation of SRS

4

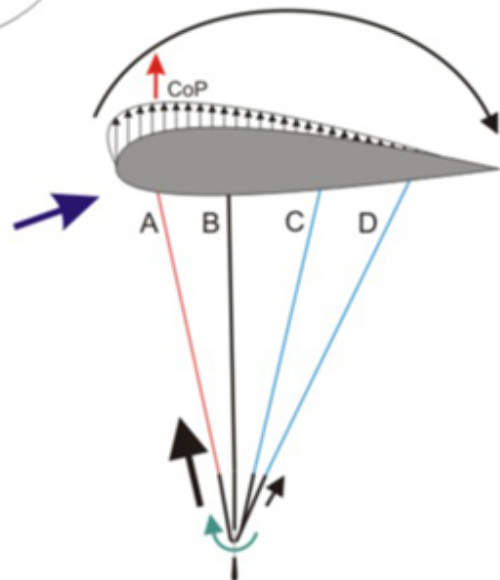

Load distribution in flight



15 INSPECTION

15.1 GENERAL

Pilots, please insure that your glider has been test flown and fully checked by your dealer before taking it into your possession.

Verify that the dealer checked and confirms that the glider is airworthy.

15.2 BRAKE SETTING

Before the first flight the pilot/ dealer has to inflate the glider, check and adjust the brake line length to his or her preference. It is important that the brakes are not set too short. If the glider is above your head the brakes should not be pulling the trailing edge down as this means that the brakes are too short. A good setting is to have about 10 cm of slack in the brake from the brake guide on the riser to the activation point of the brakes (See Diagram 16-1 below). If the pilot changes the type of paramotor, please check the brakes again to ensure that the brakes are not too short.

Since there are several hook-up points for a paramotor, the NRG PRO comes with longer brake lines than necessary. The risers also have two anchor loops for the brake line guide-pulley so that the pilot can arrange the best brake setup for his/her paramotor.

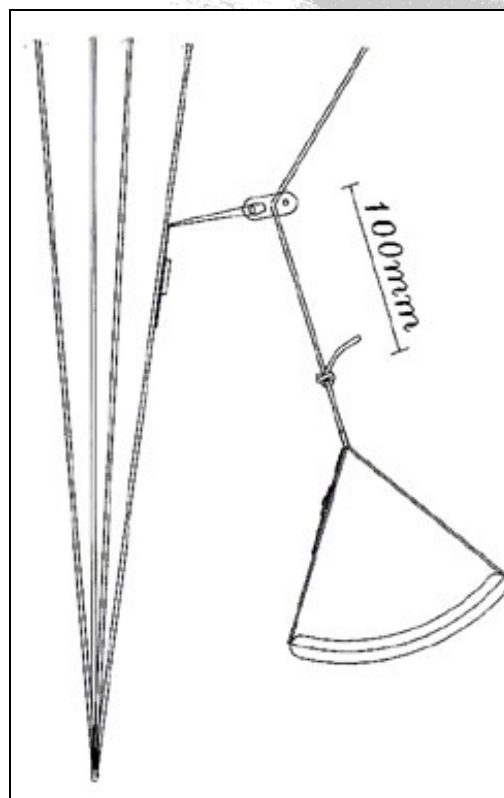

Figure 16-1 Brake Line Adjustment



15.3 Brake Operation

Two Dimensional brake configuration

Two dimensional brake arrangement combines the main steering with the tip steering. It takes a little while to get used to this system, but it allows multiple options of steering and is very intuitive.

The pictures below present the two extremes but all the range in between is possible.

When the hands are stretched to the sides, all of the trailing edge is pulled down.
Is intended for **unaccelerated** maneuvering **only**.

All of the trailing edge is pulled

The hands are stretched to the sides



When the hands are near the body only the tips are pulled down.
Is intended primarily for accelerated maneuvering.

Only the tips are pulled

The hands are near the body





15.4 FIRST CHECK AND PREFLIGHT INSPECTION

With every new glider, the following points should be checked:

- Connection points between the glider and the harness.
- Check that there are no lines twisted, tangled or knotted.
- Check that the risers and speed-system are hooked up to the harness correctly.
- Check that the trimmers are set to the neutral position or below.

15.5 REGULAR INSPECTION CHECKS

- Damage to lines, webbing and thread on the stitching of the harness and risers.
- The stainless steel connection links on the risers are not damaged and are fully closed.
- The pulleys of the speed system are free to move and the lines are not twisted.
- The condition of the brake lines, stainless steel rings and the security of the knot attaching the brake handle to the brake line.
- The sewing and connection of the lines.
- Damage to hook up points on the glider.
- Internal damage to the ribs and diagonal ribs.
- Damage to the top and bottom panels and seams between panels.

15.6 LINE MAINTENANCE

Several groups of suspension lines and one brake line are attached to each riser. The groups are called A, B, C and brake lines. The stabilizer lines are connected along with the A-lines. Superaramid lines are known to be sensitive to the influence of the elements. They must be carefully inspected periodically. In his/her own interest, the pilot must observe the following points to ensure maximum performance and safety from the glider.

- Avoid sharp bending and squeezing of lines.
- Take care that people do not step on the lines.
- Do not pull or jerk the lines if they are caught on rocks or vegetation.
- Avoid getting the lines wet. If they do get wet, dry them as soon as possible at room temperature and never store them wet. Never fly with wet lines as their tensile strength will be temporarily reduced.

IT IS **STRICTLY RECOMMENDED** TO CHANGE THE BOTTOM LINES ON EVERY PARAGLIDER ONCE A YEAR OR EVERY 100 HOURS, WHICH EVER COMES FIRST. THE REST OF THE LINES MUST BE CHECKED YEARLY AND REPLACED IF NECESSARY. THIS RECOMMENDATION IS IN LINE WITH ISRAELI REGULATIONS, BINDING IN ISRAEL. AS AN ALTERNATIVE, WE SUGGEST FOR YOU TO FOLLOW





THE REGULATIONS SET BY YOUR NATIONAL AUTHORITIES WITH REGARD TO LINE MAINTENANCE AND REPLACEMENT.

NEVER REPLACE THE LINES WITH DIFFERENT DIAMETER OR TYPE OF LINES AS ALL GLIDERS WERE LOAD TESTED FOR SAFETY IN THEIR ORIGINAL CONFIGURATION. CHANGING LINE DIAMETER/STRENGTHS CAN HAVE FATAL CONSEQUENCES.

Every six months one each of lower A, B and C line must be tested for minimum 45 % of the rated strength. If the line fails under the load test or does not return to its specified length all the corresponding lines must be replaced (e.g. if the line is rated 100 kg. it must withhold 45 kg. or more)

Professional use of gliders: Towing, tandem, schooling and competition flying requires more frequent line inspection and replacement of A, B, C, D and brake lines.

16 PARAGLIDING

The NRG PRO is designed as a Paramotor Slalom/Comp wing and *IS NOT* recommended for Free Flying

16.1 TAKE OFF

As this is not a training manual we will not try to teach you launching techniques. We will only briefly go through the different launch techniques to help you get the most out of your glider.

16.1.1 LAYOUT

Pre-flight check should be done before every flight.

Spread the glider on the ground. Spread the lines, dividing them into eight groups A, B, C, D and brake lines left and right. Make sure the lines are free and not twisted or knotted.

Make sure all the lines are on top of the glider and none are caught on vegetation or rocks under the glider. Lay out the glider in a horseshoe shape. This method insures that all the lines are equally tensioned on launch, and results in an even inflation.

The Flexon rib reinforcements will keep the leading edge open for easy inflation.

The most common reason for a bad launch is a bad layout!

16.1.2 ALPINE LAUNCH OR FORWARD LAUNCH

The NRG PRO has very good launch behaviour in no wind conditions.

For the best results we recommend the use of the following techniques: Lay out the glider and position yourself in the centre of the wing with the lines almost tight.





With a positive and constant force inflate the wing holding only the A-risers, and smoothly increase your running speed. The wing will quickly inflate and settle above your head without the tendency to stick behind.

After you leave the A-risers, apply about 15% brakes and the NRG PRO will gently lift you off the ground.

16.1.3 STRONG WIND AND REVERSE LAUNCH

The NRG PRO has a lot of lifting power and care should be taken in strong wind. It is advisable to have an assistant hold you when attempting a strong wind launch. It also helps if you walk towards the wing and leave the A-riser just before the glider gets above your head.

The assistant should let you walk in under the wing on inflation rather than resist the inflation; this reduces the tendency of the glider to lift the pilot prematurely.

16.1.4 TOW OR WINCH LAUNCHING

All APCO gliders are well suited for winching and have no bad tendencies on the winch. With towing it is important to have the wing above your head on launch and not to try and force a stalled wing into the air. This is especially important if the winch operator is using high tension on the winch. Very little brake if any need be applied on launch and during the tow. Directional changes can be made with weight shift rather than brakes. While on tow, the brake pressure will be higher and more force may be needed to make corrections than in normal flight.

For all our gliders we recommend using tow accelerating system. There are different types existing on the market. Please check with your dealer or tow operator for the recommended tow accelerator system. Use of it will eliminate any chance for accidental stalling on tow.

16.2 FLIGHT TECHNIQUES

The NRG PRO is an easy and pleasant glider to fly, it has excellent performance and can be enjoyed by a wide range of pilots.

16.2.1 FLYING SPEED

Indicated trim speed is dependant on the amount of brake the pilot is using, wing loading, altitude above sea level and the accuracy and make of speed probe. The speeds recorded in technical data were at optimum wing loading at sea level using a Flytec 6030 thus there could be a slight variation in speed range numbers that pilots records.

Speed readings in the flight reports could differ as this was measured during testing using various instruments and is an indication of the difference between trim, stall and top speed. The speed range will be the same but the actual numbers may differ.

- With 0% brake and trimmers at 0 the NRG PRO will fly at 39-48 km/h with a sink rate of 1.7m/s.
- At 25% brake the glider will fly at 33-34km/h with minimum sink rate 1.4 m/s.
- The best glide angle is achieved with 0% brakes and 0% speed system.
- With 80% brake the glider will fly at about 29km/h and will be close to the stall point 27km/h.





CAUTION:

APART FROM WHEN FLARING AT LANDING THERE SHOULD BE NO REASON TO FLY WITH 70% TO 100% BRAKE. THE SINK RATE OF THE GLIDER WILL BE EXCESSIVE AND THERE WILL BE A POSSIBILITY OF ENTERING A DEEP STALL OR FULL STALL SITUATION. THERE IS ALSO THE RISK OF GOING NEGATIVE OR ENTERING A SPIN WHEN ATTEMPTING TO TURN THE GLIDER NEAR THE STALL SPEED.

WARNING:

The use of the speed system in turbulent conditions or close to the ground is dangerous. While flying with the accelerator, the glider has a reduced angle of attack and is therefore more susceptible to turbulence and may collapse or partially deflate. Gliders react faster when accelerated and may turn more. The accelerator should immediately be released in this case.

16.2.2 THERMAL FLYING

NRG PRO has high internal pressure and needs very little pilot input even in very turbulent conditions.

In light lift it is advised to make flat turns to keep the glider from banking too much and avoid increasing the sink rate.

In strong lift conditions it is most effective to make small turns in the core with relatively high bank.

For the best climb rate in ridge lift we recommend using about 15% to 20% brake and trimmer fully closed.

16.2.3 ASYMMETRIC COLLAPSE

If one side of the glider partially folds or collapses it is important to keep your flying direction by applying weight shift and some brake on the opposite side.

The wing should re-inflate on its own without any input from the pilot.

To help re-inflation it is possible to pull some brake on the collapsed side and release immediately.

In the event of a big deflation, i.e. 70%, it is important to apply brake on the inflated side of the wing, but care must be taken not to pull too much as you could stall the flying side.

The glider is very solid and has a strong tendency to re-inflate after collapse.

16.2.4 CRAVAT

In case a cravat should occur from an asymmetric collapse or other manoeuvres, it is important to keep your flying direction by applying some brake on the opposite side and then it can usually be opened by pulling down on the stabilo line of the affected side while countering the turn with the opposite brake and weight shift.

16.2.5 FRONT STALL OR SYMMETRIC COLLAPSE

In the event of a front stall the glider will normally re-inflate on its own immediately without any change of direction. To speed up re-inflation briefly apply 30%-40% brake (to pump open the leading edge). **Do not hold the brakes down** permanently to avoid an unwanted stall.





16.2.6 B-STALL

The NRG PRO has a very clean, stable B stall.

To enter the B stall the pilot has to pull the first 20-cm slowly until the glider loses forward speed and starts to descend vertically.

Then the pilot can pull more on the B until he/she attains a stable 7 to 9 m/s descent rate.

The Glider has no tendency to front rosette or become pitch unstable. To exit the B stall the pilot releases the B slowly until the glider has regained its shape and then the **last 15 cm fast** to prevent the glider from entering deep stall.

The NRG PRO can be controlled directionally in the B stall by pulling more on one B riser than on the other to create a turn in any direction. The B-stall is a safe controlled way of losing altitude fast without any forward speed.

16.2.7 BIG EARS

Big ears manoeuvre is not available using the NRG PRO.

16.2.8 DEEP STALL OR PARACHUTAL STALL

Under normal flying conditions the NRG PRO will have no tendency to enter deep stall. All gliders can however under certain conditions enter and stay in deep stall configuration (as a result of ageing of materials, improper maintenance or pilot induced).

16.2.8.1 Signs of parachutal stall

- The pilot has very little or no forward airspeed and no wind in his face.
- The glider will be fully open but the cells will be bulging in and not out on the bottom surface.
- The glider might have a very slow turning sensation.
- You will have an increased vertical descent.

16.2.8.2 Exit from parachutal stall

It is important to recognize this situation. Most accidents involving parachutal stall happen because the pilot did not realize that he was in deep stall.

The best way to exit a parachutal stall is to pull all the A risers down to get the wing flying again. The pilot can pull the riser down until the wing starts to fly again. The moment the wing starts to fly the pilot should release the A risers, or the wing might suffer a frontal collapse.

Alternatively the pilot can push the speed bar to lower the angle of attack and get the wing flying again.

By pulling one or both brakes while in deep stall the pilot can accidentally enter a full stall or spin. (Not recommended)

16.2.9 SPIRAL DIVES

The NRG PRO has very good behaviour in spiral and has no tendency to stick in the spiral. By progressively applying brake on one side the glider can be put into a spiral dive. Safe high sink rates can be achieved like this. The spiral has to be exited slowly by releasing the brake over one complete turn or the glider may pitch forward and possibly suffer a collapse.

Care must be taken that the pilot has enough height to exit the spiral safely.

Sink rates in excess of 19m/s can be obtained.





CAUTION:

SOME GLIDERS CAN BE NEUTRAL IN SPIRAL AND MAY NOT EXIT WITHOUT PILOT INPUT. TO EXIT A NEUTRAL SPIRAL THE PILOT HAS TO LEAN HIS/HER WEIGHT TO THE OUTSIDE OF THE TURN OR APPLY BRAKE INPUT TO TURN OUT OF THE SPIRAL (ON THE OUTSIDE WING). AS SOON AS THE GLIDER STARTS TO SLOW DOWN IN THE SPIRAL THE OUTSIDE BRAKE MUST BE RELEASED.

PILOTS CAN SUFFER BLACK OUTS IN SPIRALS AND THE PILOT HAS TO EXIT THE SPIRAL AS SOON AS he/she FEELS ANY ABNORMAL SYMPTOMS (Black dots in field of vision or light-headedness).

16.2.10 STRONG TURBULENCE

NEVER FLY IN STRONG TURBULENCE!

If you unexpectedly encounter strong turbulence, fly with **trimmers open and no brakes applied** to let the reflex stabilize the glider, use only secondary brake handles (tip steering) and land as soon as possible.

16.2.11 STEERING NOT FUNCTIONING

If the pilot cannot reach the brake or steering lines for any reason or if they are not functioning properly, (for example: If they break on a damaged point) the pilot can control the glider by pulling down on the rear risers.

Care must be taken when steering like this, as much less input is needed to turn the wing and the response of the wing is also much slower than when using the brakes.

IF YOU PULL TOO MUCH ON ONE OR BOTH RISERS THE GLIDER WILL SPIN OR STALL.

On the landing flare the pilot should be especially careful not to stall the glider too high.

16.2.12 LANDING

Before landing, the pilot should determine the wind direction, usually by checking a windsock, flags, smoke or your drift over the ground while doing one or more 360° turns.

- Always land into the wind.
- At a height of about 50 meters your landing setup should begin. The most commonly used one is to head into the wind and depending on the wind strength the pilot should reach his/her landing point by making s-turns.
- At a height of about 15 meters the final part of your descent should be made at trim speed into the wind.
- At a height between half a meter and one meter you can gently flare the glider by pulling gradually down on the brakes to the stall point. When top-landing it is sometimes not necessary to flare or a much smaller flare may be required, especially in strong ridge conditions.





16.2.13 TREE LANDING

If it is not possible to land in an open area, steer into the wind towards an unobstructed tree and do a normal landing approach as if the tree is your landing spot. Flare as for a normal landing. On impact hold your legs together and protect your face with your arms.

After any tree landing it is very important to check all the lines, line measurements, and the canopy for damage.

16.2.14 WATER LANDING

As you approach landing, release all the buckles (and cross-bracing if present) of the harness except for one leg. Just before landing, release the remaining buckle. It is advisable to enter the water downwind. Let the wing pitch completely forward until it hits the water with the leading edge openings; the air inside will then be trapped, forming a big air mattress and giving the pilot more time to escape. Less water will enter the canopy this way, making the recovery much easier. **Get away from the glider and lines as soon as possible**, to avoid entanglement. Remember that a ballast bag can be emptied and then inflated with air for a flotation aid.

The wing should be carefully inspected after a water landing, since it is very easy to cause internal damage to the ribs if the canopy is lifted while containing water. Always lift the canopy by the trailing edge, not by the lines or top or bottom surface fabric.





17 POWERED FLYING

NOTE: Before each start it is necessary to perform a complete check of the paraglider, harness and power unit.

In powered flight most of the wing characteristics remain as described above (chapter 15). Still there is additional information needed, concerning power output, proper matching of the wing/engine/propeller etc. APCO can try to give advice on some possible tested combinations, but if you contact your nearest APCO dealer or frame manufacturer they will always be ready to help.

17.1 FIRST FLIGHTS

In order to get familiar with your wing we recommend flying with trimmers at the 0 position first in stable non-turbulent weather.

Once you feel confident with your wing, you can start experimenting with faster trim settings and speed system, taking all precaution. Learn to use all of the additional speed of the NRG PRO

Remember: do not exceed the envelope of weather, wing and other parameters to insure safe flying.

17.2 TAKE-OFF

17.2.1 FORWARD LAUNCH

Please check wind direction, even when it seems that there is no wind at all, there is always some drift.

Therefore be careful in determining the conditions, since in PPG flying it is most important that the launch and initial climb are performed with a head wind (the danger of losing your airspeed while crossing the wind gradient is greatly reduced).

Special attention must be paid to trees, power lines and other obstacles, including the possibility of emerging rotors.

Launch preparation

Lay out the paraglider in an arc, downwind of the power unit, with all suspension lines taut and pointing toward center of the power unit. The risers are to be laid on the ground.

Set the trimmers in 0 positions.

Make sure that you warm up the engine while standing windward of the wing. Stop the engine before clipping in the risers.

Now have quick checks if:

- Helmet is on and fastened.
- The risers are clipped into the carabiners.
- The trimmers are properly set.
- Propeller is clear.
- Speed system is functioning, problem free.
- Steering lines and handles are free and not twisted.
- The engine delivers full power.
- Take off area is clear of obstacles and free to use.





When you are sure all is OK, you can clip in the wing and execute launch as described in paragraph 17.1.2.

From now on you should steer / handle the paraglider facing forward, without looking back over your shoulder. If the wing is retreating and behind you at a low angle, do not turn around as there is a danger of falling on your back and damaging the propeller and catching lines in the propeller, so it should be avoided.

During take-off, when you feel the tension on both risers to be equal, make sure the wing is overhead, open up full power and lean back to counter the engine thrust, so that it can push you forward rather than towards the ground.

The best option is not to use the brakes, allowing the paraglider to rise as it was laid out. If it starts to deviate from its course, pull the opposite riser and run under the centre of the wing while continuing in the initial direction.

If the wind suddenly drops, give a strong pull on the risers.

If the paraglider falls to one side or back too far to lift again - kill the engine, cease launch and check the conditions once again.

As the wing rises, the forces grow lighter and it should stabilize above your head without overshooting.

This is the best moment to check if it is inflated well and the lines are not tangled, **but do not stop or turn.**

Once you feel the forces on the risers decrease, run faster and let go of the risers.

See if there is already any opposition on the brakes and, if necessary, use them to correct direction or to increase lift at take-off.

Remember:

- If the cage of your power unit is not stiff enough, the risers will strain during launch and can deform it to the extent of collision with the propeller. Before applying full throttle, see that the cage does not catch any lines.
- Any brake operation (or steering input in general) should be smooth and gentle.
- Do not try to take off until you have your wing overhead. Hitting power before that can cause dangerous oscillations.
- Do not sit in the harness (run) until you are sure you are flying!
- The faster the trim setting is, the more brake input is required to take off.





17.2.2 REVERSE LAUNCH (In strong wind)

Reverse launch can be executed holding in one hand both A risers and one brake, with throttle and the second brake in the other hand. A moderate wind is by far the best way. In weaker wind it is better to prepare for forward launch, as running backwards with an engine on your back is not an easy thing to do.

It is reasonable not to pull the wing up until you are really determined to launch, especially when it is clipped in.

Lay down the paraglider with its trailing edge against the wind.

Unfold the wing enough to find the risers and check that no lines are looped over the leading edge.

Stretch the risers against the wind, separating the right and left one.

We suggest that you lay the risers in the same way as you will be turning during reverse launch, and place one riser over the other, with rear risers on top.

It should be done this way because once you clip in, the cage of your power unit will make turning on your own very difficult.

Now run the pre-launch checklist.

After warming up the engine put the power unit on, turn to face the wing, go to the risers and clip them in the appropriate carabiners.

Pull on the front and rear risers to open the cells.

It is a good idea to pull up the wing briefly in order to check that the lines are not tangled.

Holding the risers, brakes and throttle as described above, pull the front risers and raise the wing over your head.

On most occasions you won't have to use the brakes.

Once you have it overhead, turn around, open the throttle and take off.

Remember:

- You are launching with your hands crossed. You have to perfect this technique before trying it with a running engine on your back.
- Any brake operation (or steering inputs in general) should be smooth and gentle.
- Do not try to take off until you have your wing overhead, applying the throttle early can cause dangerous oscillations.
- Do not sit in the harness until you are sure you are flying!
- The faster the trim setting is, the more brake input is required to take off.
- When clipping in the crossed risers, you can find proper connection of the speed system particularly hard. Be careful not to confuse the risers!





17.2.3 CLIMBING

Once you are safely airborne, continue heading against the wind, using brakes to correct the direction.

Do not try to climb too steeply.

In powered flight the NRG PRO behaves more like an airplane than a paraglider, and it is good idea to regard it as such. If there are no obstacles present, it is by far safer to fly level for a while after take-off, clearing the ground gradually, gaining some speed before converting it to height with a brief pull on the brakes.

Another reason not to try climbing too steeply is the risk connected with engine failure at low altitude.

NRG PRO in a steep climb does not stay behind as much as conventional paragliders. The SRS prevents or delays possible stall, but low speed at low altitude carries inherent danger of stall which even SRS will not be able to fully prevent

Besides, you should always be able to land safely in case of engine malfunction, so it's better not to take unnecessary risk and always fly with a safe margin of speed and height

Depending on the power unit geometry, it is possible that after take-off you will notice a propeller torque (known as P-factor).

It will try to turn you around, so counter-steer with a brake, trimmer set or harness cross-bracing.

NRG PRO'S risers feature two hook in points, to help adjusting your ppg setting against torque.

When climbing steeply with slow trim settings and high power output beware of the possibility of stall.

Due to considerable vertical distance between thrust axis and wing chord - the range of safe power operation is closely connected to your skills and equipment.

Power-unit induced oscillations:

Certain configurations of engine weight, output and propeller diameter can cause oscillations, during which the pilot is being lifted to one side by the torque effect, swings down due to his weight, and then is lifted again and so on.

To avoid this you can:

- Change the throttle setting.
- Adjust the cross bracing to counteract the torque (if there is one present).
- Shift yourself to the other side of the harness and/or change the trimmer setting.

The best method is to fasten opposite cross-bracing, or apply some weight-shift.

Such oscillations usually occur at full power - the greater the engine output and propeller diameter, the bigger the swings.

In addition pilot reactions can often be wrong or come too late, increasing the problem instead of solving it.

In this case the safest way to deal with this question is to close the throttle and release the brakes.

Less-experienced pilots especially tend to overreact.

This is called a pilot-induced oscillation, and the proven solution is to **leave the brakes alone**.





17.3 LEVEL FLIGHT

If you have a variometer or altimeter – check it regularly.
In level flight it is very easy to start climbing unintentionally.
The instrument will help you optimize speed and fuel economy.
Of course each flight depends on configuration of your gear, but due to NRG PRO's ability to fly safely without constant piloting, it will let you adjust everything to the best effect.
Good knowledge of weather conditions (e.g. wind at different altitudes) and knowledgeable use of thermals, convergence or other kinds of lift will help you greatly reduce fuel consumption and increase flight range.
Of course the engine is always there to bring you to the right place.
Do not hesitate to thermal with the NRG PRO in order to win some altitude and spare fuel - you will be surprised how efficient it is.
Closing the trimmers will make the climb ratio even better.

17.4 TRIMMERS AND SPEED-SYSTEM SETTINGS

You are free to experiment with all possible settings, **as long as you are at safe altitude and watch the weather**. Fully opened trimmers increase the speed of the wing and with it overall penetration and stability, **but when trimmers are opened it is highly recommended to use secondary steering only (stabilo steering), using the main brake handles will increase the risk of a collapse**.

As forces on the brakes grow at high speeds, the weight shifting or steering with STABILO STEERING system becomes increasingly effective.

STABILO STEERING system can be used in all trimmer and speed system settings, also in combination with main brake handles. At maximum speed bar and fully opened trimmers we **highly recommend** steering with STABILO STEERING system.
Strength needed to initiate the turn will be smaller and there will be no decrease in speed.

On the other hand, slow trimmer settings decreases sink and steering forces, so it is possible to efficiently use the thermals.

Worth noting is the NRG PRO's impressive speed range -the maximum speed is almost three times greater than stall speed.

Turns can be much improved by additional use of throttle, speed-system etc. Once you master these techniques, you will be able to execute fully coordinated and effective turns.

REMEMBER:

Trimmer setting is another part of the pre-start check list!
If it will be asymmetric, the wing will turn all the time.





17.5 LANDING

In PPG flying there are two kinds of landing: with and without power.

17.5.1 POWER OFF LANDING

At an altitude of 50 meters switch the engine off and glide as you would on a conventional paraglider.

It reduces the chances of damaging the propeller on landing, but on the other hand there is only one attempt possible -so it has to be done right!

NRG PRO preserves the energy well, so there is a long float necessary, exchanging the abundant speed for lift with your brakes.

17.5.2 POWERED LANDING

Make a flat approach with the engine idling, then level out and lose the speed before final flare.

Immediately on landing, switch off the engine.

The main advantage of this procedure is of course the possibility of going around with the wing again (repeating the approach) if anything goes wrong.

Still, if you forget to switch off the ignition before the wing falls down, there is a considerable risk of damaging propeller, catching lines in it or even suffering injuries connected with falling on your running engine.

Remember:

- Whenever possible, get to know the landing field before taking off.
 - Check the wind direction before planning the approach.
 - Landing with power off requires much less space.
 - In case of any doubt, practice the landing until you feel totally safe
 - Never place the power unit downwind of the paraglider.
 - Check, double check and then check once again that there is no fuel leakage.
 - Do you have enough fuel for the flight? It is always better to have too much than too little!
 - Check that there is nothing loose in the harness that could possibly contact the propeller in flight.
 - Whenever you encounter a problem, fix it **AT ONCE** however small it is!
 - Always put on and lock helmet before getting in the harness.
 - Before each launch run a full pre-flight inspection.
 - After landing, continue to maintain the wing's direction straight, as on turning you always risk getting lines in the propeller.
 - Turn only if there is danger.
-
- Do not fly over water, between trees or power lines and other places where engine failure will leave you helpless, always make sure you have possibility for emergency landing.
 - Mind the turbulence caused by other gliders or even by yourself, especially when flying low.





- It is not recommended to let go of the brakes below 100 meters, because a possible power unit malfunction may require immediate attention.
- In general never trust your engine, as it can stop at any moment. Always fly prepared for engine failure.
- Unless it is absolutely necessary (e.g. collision avoidance), do not execute tight turns against the torque direction.
Especially when climbing you can easily enter a stall or negative spin.
- Do not fly with tail wind at low altitudes,- it narrows your options !
- Do not wait for the problem to grow - any change of engine sound or a vibration may indicate a problem. You'll never know until you land and check it out!
- Be certain of your navigation
- Remember that not everyone is fond of your engine noise.

18 PACKING

Spread the wing completely out on the ground. Separate the lines to the left and the right side of the glider. If the risers are removed from the harness, join the two risers together by passing one carabiner loop through the other. This keeps them neatly together and helps to stop line tangles.

Fold the canopy alternately from the right and left sides, working towards the centre, press out the air, working from the rear towards the front. Place the risers at the trailing edge of the folded canopy and use them to finally roll up the canopy.

19 MAINTENANCE & CLEANING

Cleaning should be carried out with water and if necessary, gentle soap. If the glider comes in contact with salt water, clean thoroughly with fresh water. **Do not use solvents of any kind**, as this may remove the protective coatings and destroy the fabric.

19.1 BUTT HOLES (Velcro closure on trailing edge tip)

In order to empty sand and small stones from the glider simply shake the sand or small stones into the wing tip and open the **Butt holes (Velcro closure on trailing edge tip)** to empty. Do not forget to close the **Butt holes** afterwards.





20 STORAGE

When the glider is not in use, the glider should be stored in a cool, dry place. A wet glider should first be dried (out of direct sunlight). Protect the glider against sunlight (UV radiation). When on the hill keep the glider covered or in the bag. Never store or transport the glider near paint, petrol or any other chemicals.

Do not leave your paraglider in the trunk of a car or exposed to the sun.

Temperatures on a hot summer's day in a closed environment: car, etc. can easily reach over 60°C

At these temperatures Nylon permanently changes its characteristics which may alter the behavior and shape of the wing.

It will cause permanent damage to the paraglider, rendering it non-airworthy. APCO's warranty will not be applicable.

21 DAMAGE

Using spinnaker repair tape (for non-siliconized cloth) can repair tears in the wing (up to 5cm). A professional repair facility should repair greater damage.

22 GENERAL ADVICE

A qualified person or agent of the company should check the glider every year.

The glider is carefully manufactured and checked by the factory. Never make changes to the wing or the lines. Changes can introduce dangerous flying characteristics and will not improve flying performance.

Do not put the glider in direct sunlight when not necessary. In order to protect the glider during transportation or waiting time we recommend one of our lightweight storage bags.

If you have any doubts about flying conditions - do not begin.

If you have any questions, please contact your dealer or us.

Lastly, be equipped with a certified emergency parachute and helmet on every flight.





23 NRG PRO 16.5 SKETCHES

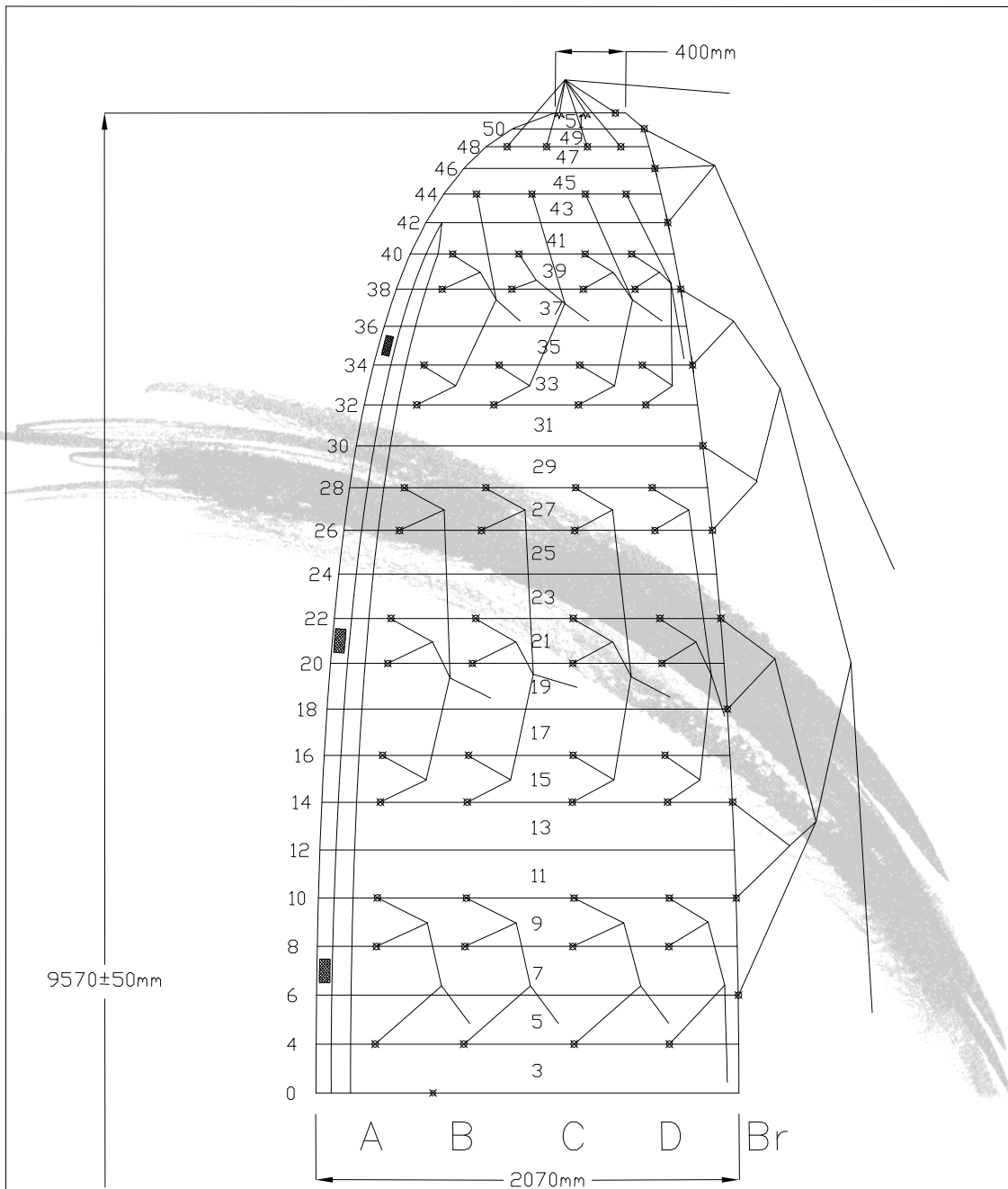

* All measurements are in mm

Drawn by Adam Wechsler	Part N	Toll ±10	
Date 11.08.14	Name	Drawing N	
Scale	Lines sketch	NP.15.10.38	
Approved Anatoly Cohn		Product	Revision
APCO Aviation LTD. 		NRG Pro 16.5	0





24 NRG PRO 17.5 SKETCHES

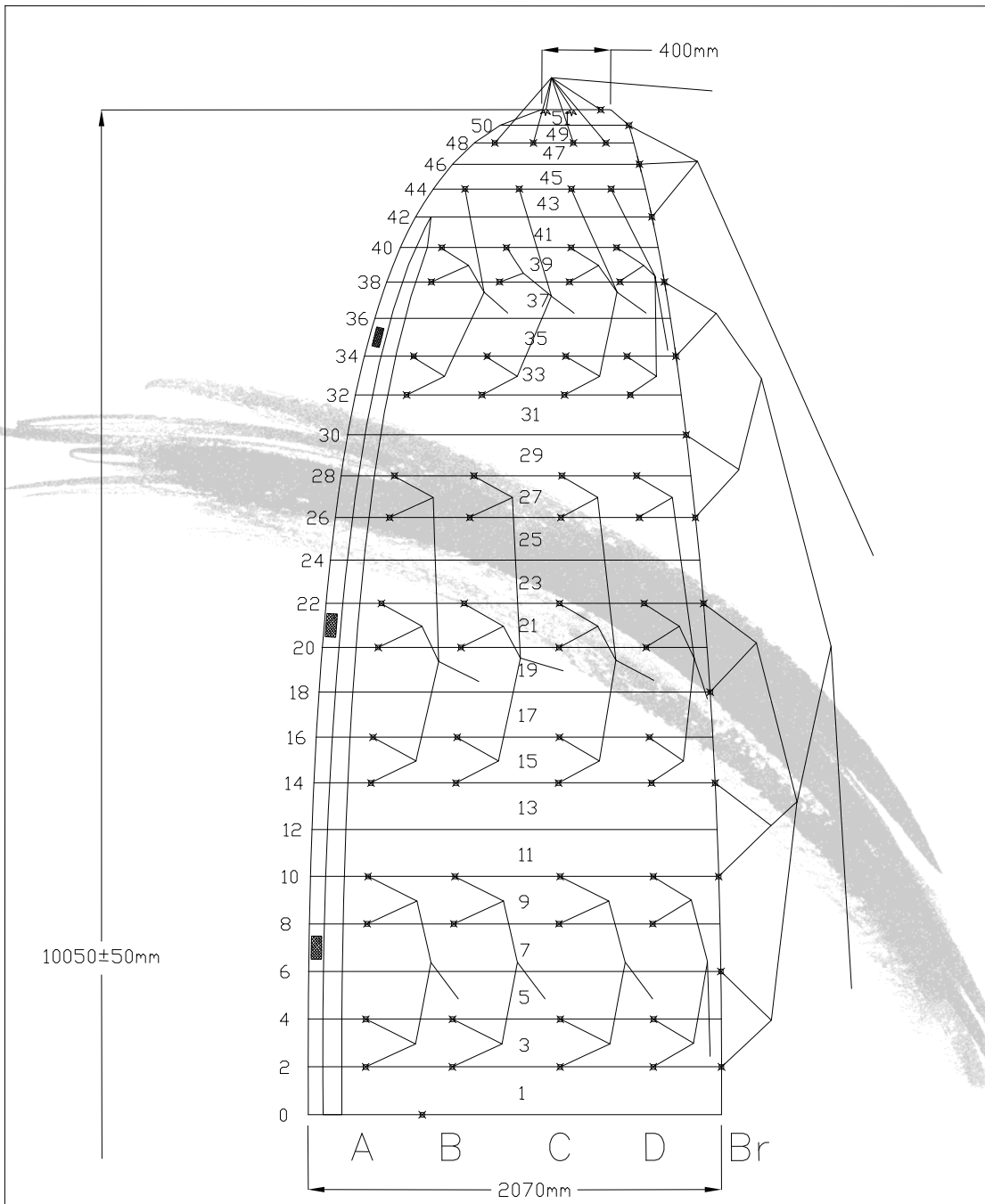

* All measurements are in mm

Drawn by Adam Wechsler	Part N	Toll ±10	
Date 28.07.14	Name	Lines sketch	Drawing N NP.15.10.38
Scale			
Approved Anatoly Cohn		Product NRG Pro 17.5	Revision 3
APCO Aviation LTD. 			





25 NRG PRO 18.5 SKETCHES

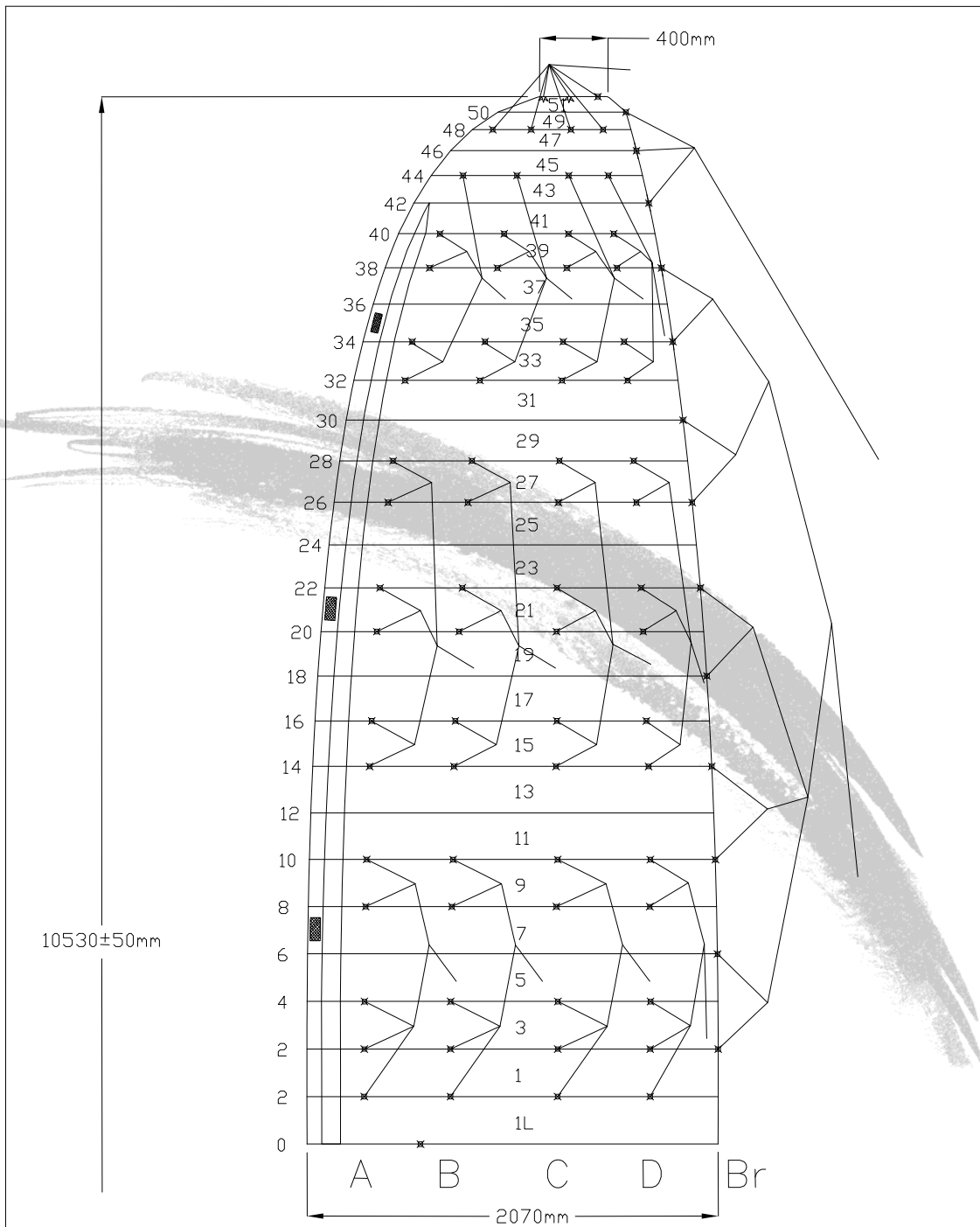

* All measurements are in mm

Drawn by Adam Wechsler	Part N	Toll ±10	
Date 28.07.14	Name	Drawing N	
Scale	Lines sketch		NP.15.10.38
Approved Anatoly Cohn	Product		Revision
APCO Aviation LTD. 		NRG Pro 18.5	1



26 NRG XC 16.5 SKETCHES

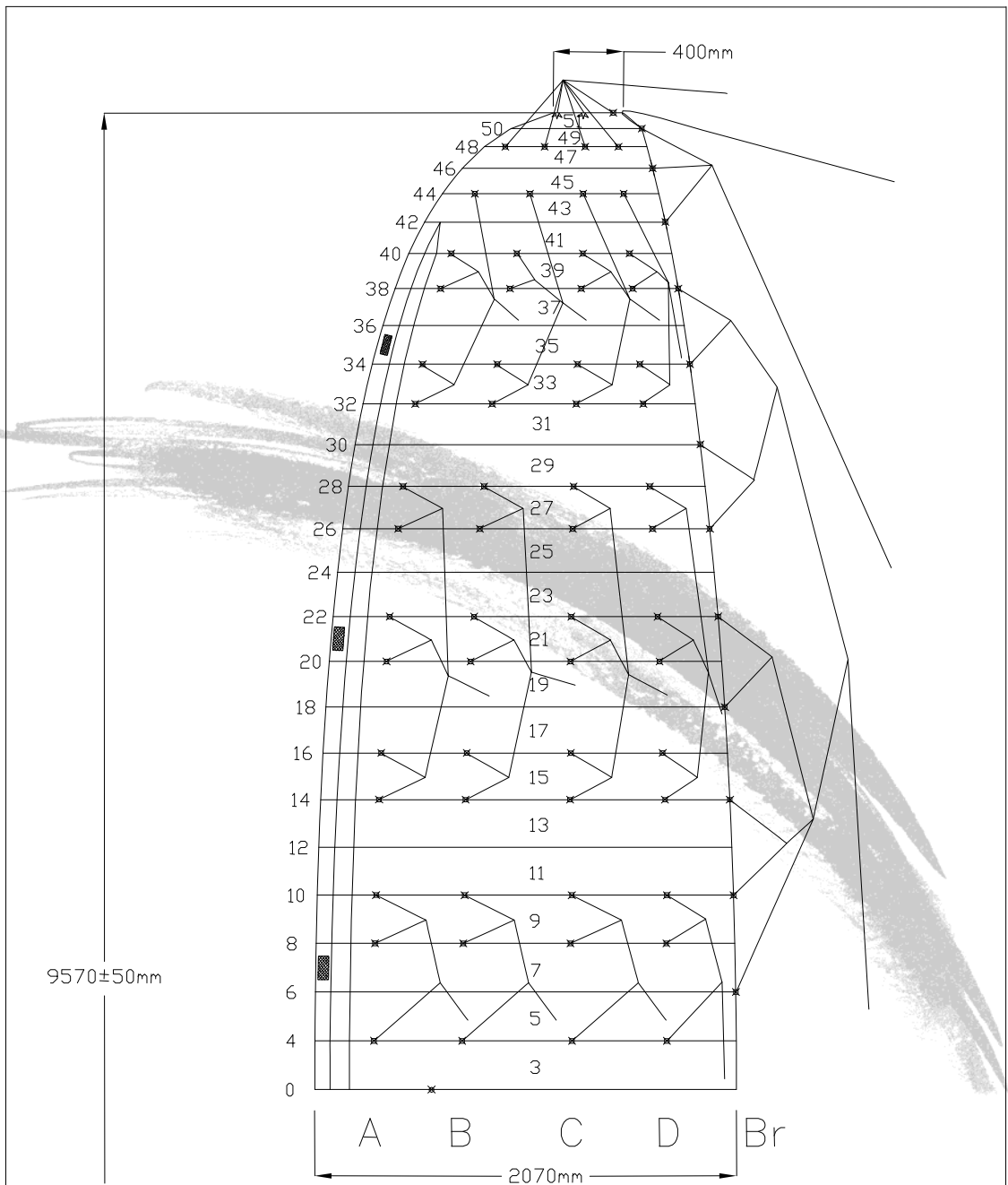

* All measurements are in mm

Drawn by Adam Wechsler	Part N	Toll ±10	
Date 14.05.15	Name	Drawing N	
Scale	Lines sketch		
Approved Anatoly Cohn			
APCO Aviation LTD. 		Product NRG XC 16.5	Revision 0





27 NRG XC 17.5 SKETCHES

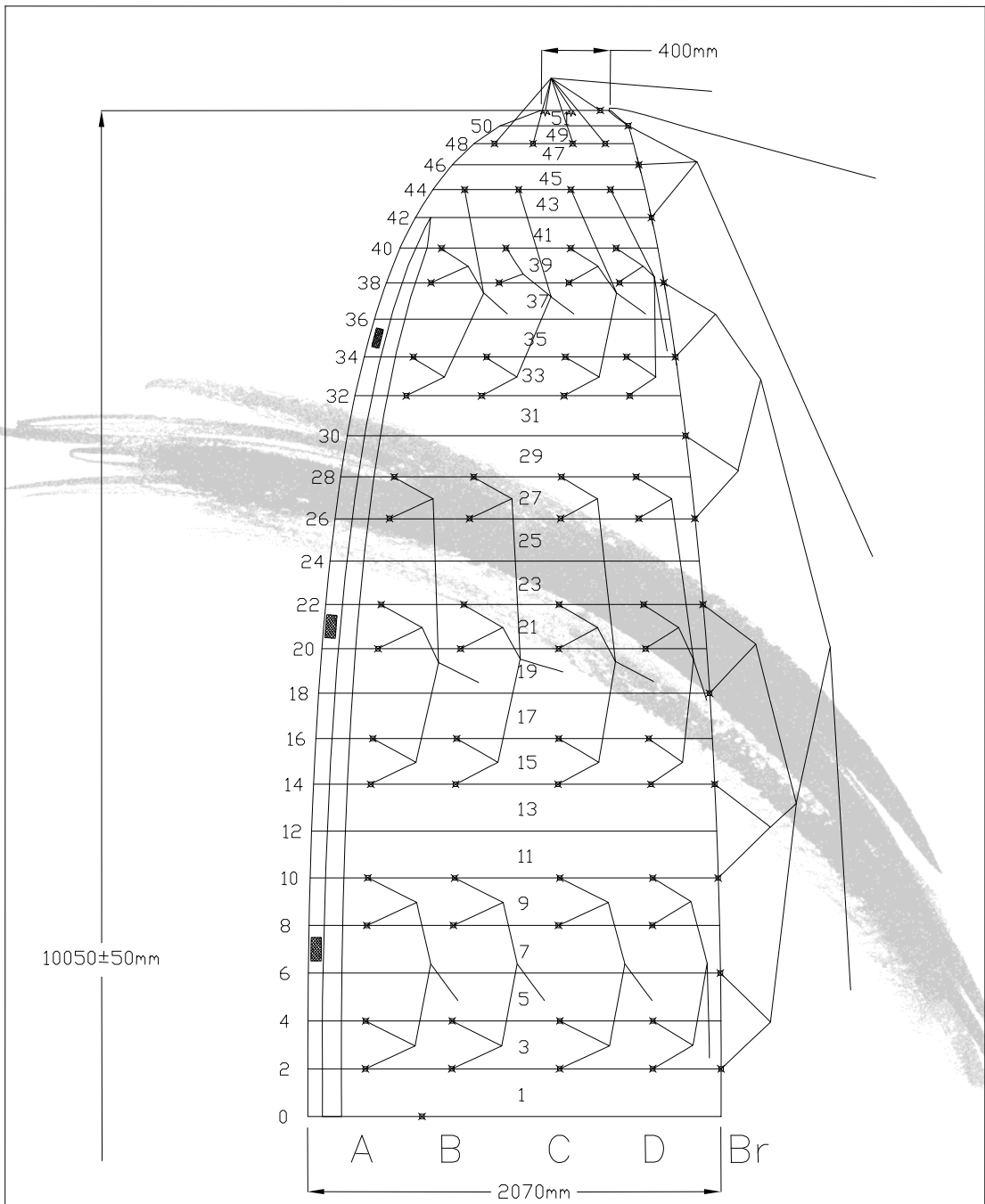

* All measurements are in mm

Drawn by Adam Wechsler	Part N	Toll ±10	
Date 31.03.15	Name	Drawing N	
Scale	Lines sketch		
Approved Anatoly Cohn	Product		Revision
APCO Aviation LTD.	NRG XC 17.5		1





28 NRG XC 18.5 SKETCHES

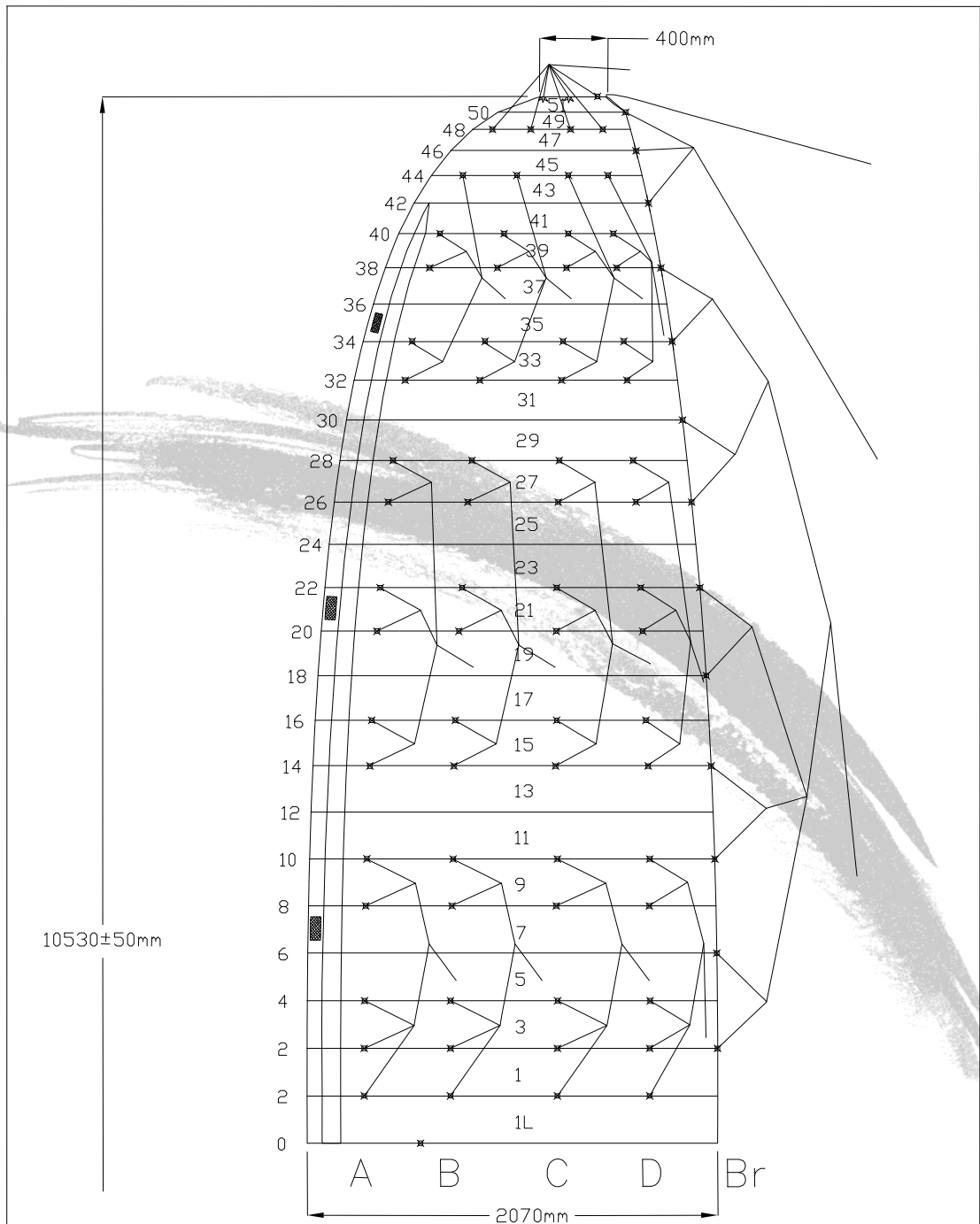

* All measurements are in mm

Drawn by Adam Wechsler	Part N	Toll ±10	
Date 14.05.15	Name	Drawing N	
Scale	Lines sketch		
Approved Anatoly Cohn	Product		Revision
APCO Aviation LTD.	NRG XC 18.5		0





APCO wishes you many hours of enjoyable flying.

Take Air!

